

HM-G630-LENS

Interchangeable Lens



The interchangeable lens series is often used with handheld thermal cameras to expand the focal length of the original camera to different ranges, so as to obtain different FOVs and scene scopes.

Key Features

- FOV (Field of View): 7.6° (H) × 6.1° (V) @ G60; 5.7° (H) × 4.3° (V) @ G40
- Compatible with G40, G60

Specification

Thermal Module	
Focal Length	82 mm
FOV (Field of View)	7.6° (H) × 6.1° (V) @ G60 5.7° (H) × 4.3° (V) @ G40
IFOV (Spatial Resolution)	0.21 mrad
Aperture	F1.3
Min. Focusing Distance	3.2 m (3.5 yd)
General	
Working Temperature Range	-20°C to 50°C (-4°F to 122°F)
Weight	628 g
Dimension	100.9 mm × φ78 mm

Available Model

HM-G630-LENS

Dimension

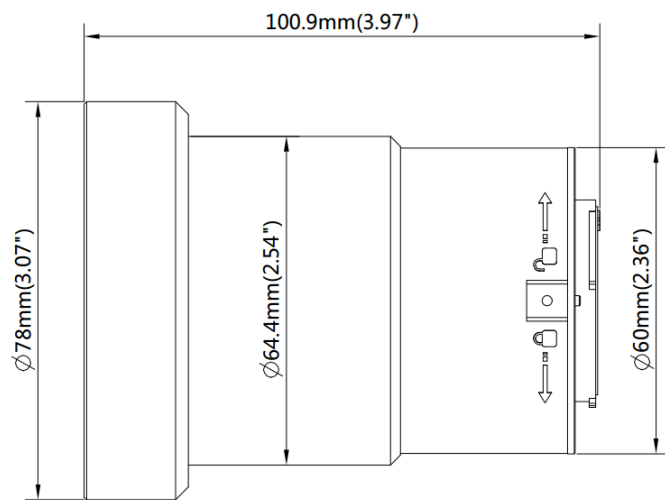
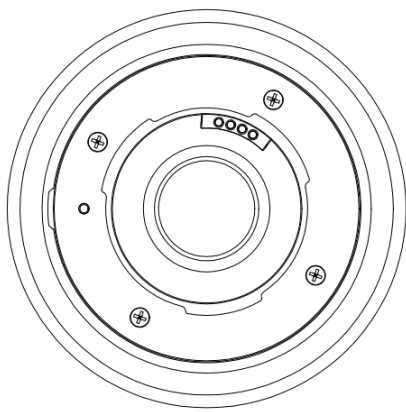

COMPLIANCE NOTICE: The thermal series products might be subject to export controls in various countries or regions, including without limitation, the United States, European Union, United Kingdom and/or other member countries of the Wassenaar Arrangement. Please consult your professional legal or compliance expert or local government authorities for any necessary export license requirements if you intend to transfer, export, re-export the thermal series products between different countries.



 HIKMICRO Thermography  hikmicro_thermography  HIKMICRO Thermography  HIKMICRO  info@hikmicrotech.com  <http://hikmicrotech.com/en>

room 313, unit B, building 2, 399 danfeng road, xixing subdistrict, binjiang district, hangzhou, zhejiang
@hangzhou microimage software co., Ltd .2020 | data subject to change without notice!